

SOLUTIONS YOUR WAY.

LÁBATLANI
VASBETONIPARI ZRT.
Member of the RAIL.ONE GROUP

RAILONE 



**INNOVATÍV MEGOLDÁSOK ÉS FENNTARTHATÓ
VASÚTI PÁLYASZERKEZETEK**

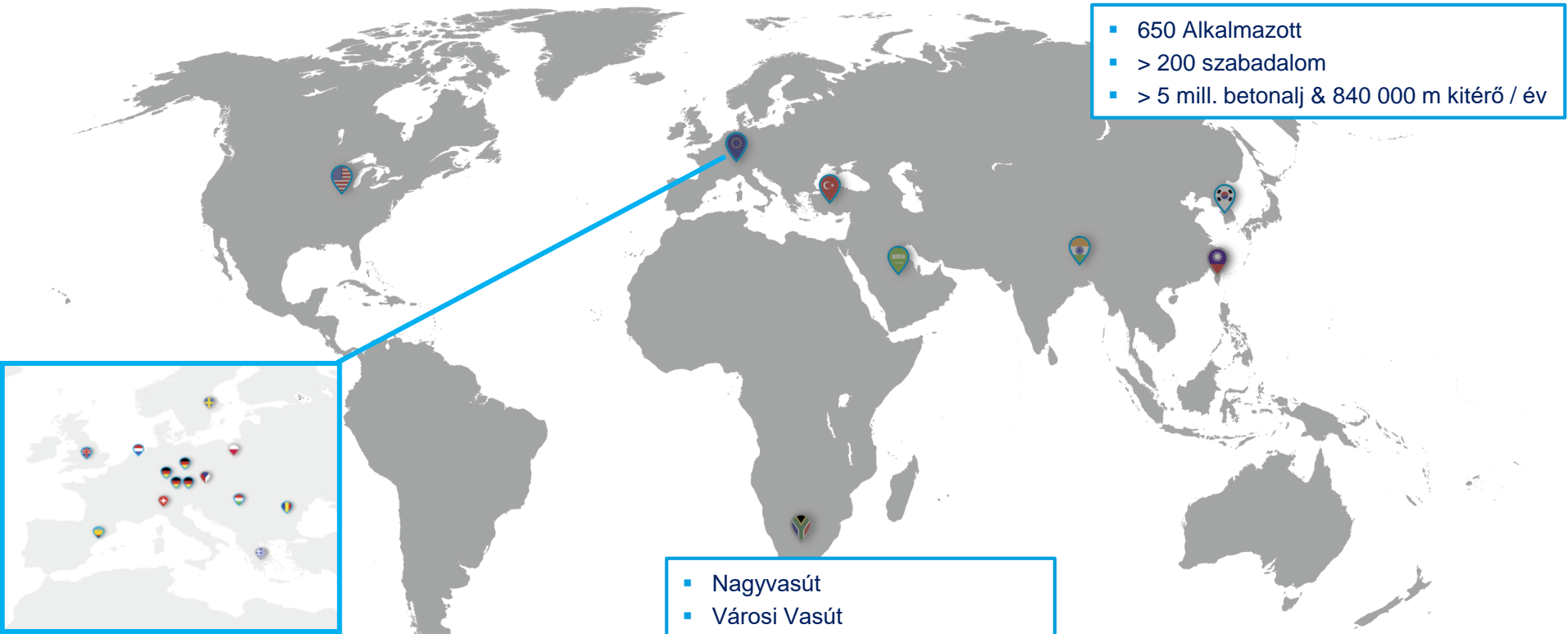

- 650 Alkalmazott
- > 200 szabadalom
- > 5 mill. betonalj & 840 000 m kitérő / év

- Nagyvasút
- Városi Vasút
- Tervezés / Műszaki tanácsadás
- Építési felügyelet

📍 Country with own production location(s)
 🏢 Country with distribution partner and/or license factory

Jelentős Nemzetközi Jelenlét

TÖBB MINT 250 BETONALJ TÍPUS

Vasúti
pályaszerkezetek

Zúzottkőágyazatos vágány

Lemzes Pályaszerkezet

Nagyvasút

Városi Vasút

Nagyvasút

Városi Vasút

Vágány- / kiterőaljok

Vágány- / kiterőaljok

Getrack

Nagypaneles rendszer

Beton aljak

Kompozit aljak

Beton aljak

Kompozit aljak

Rheda 2000

Rheda City

Nagyvasút & Városi Vasút

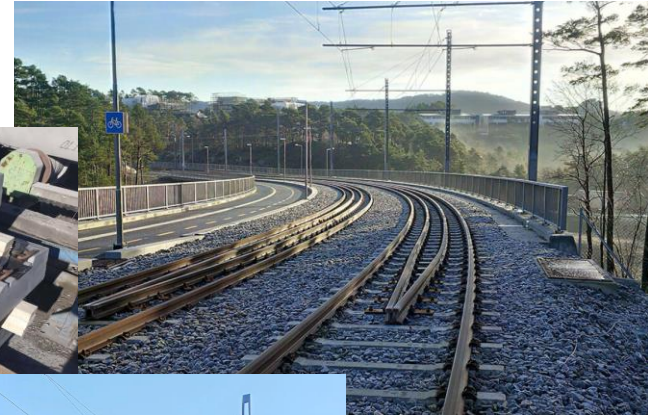

BETONALJAS VÁGÁNYSZERKEZETEK

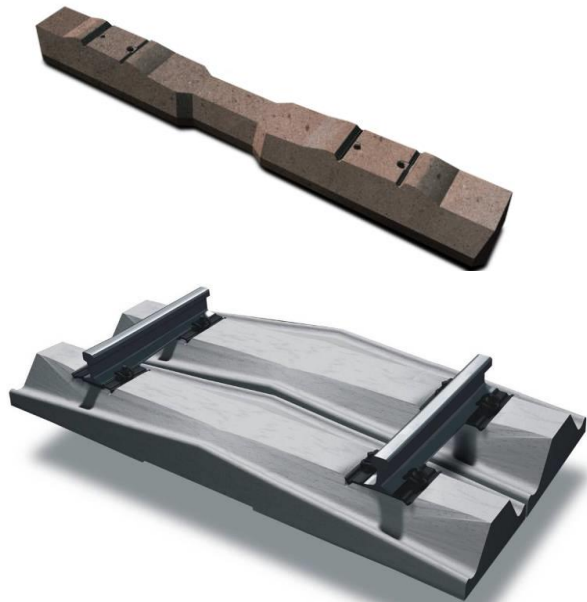

Betonaljából, zúzottkőágyazatra épített
„betonelmezes pályaszerkezet”

CSUKLÓS KITÉRŐALJAK

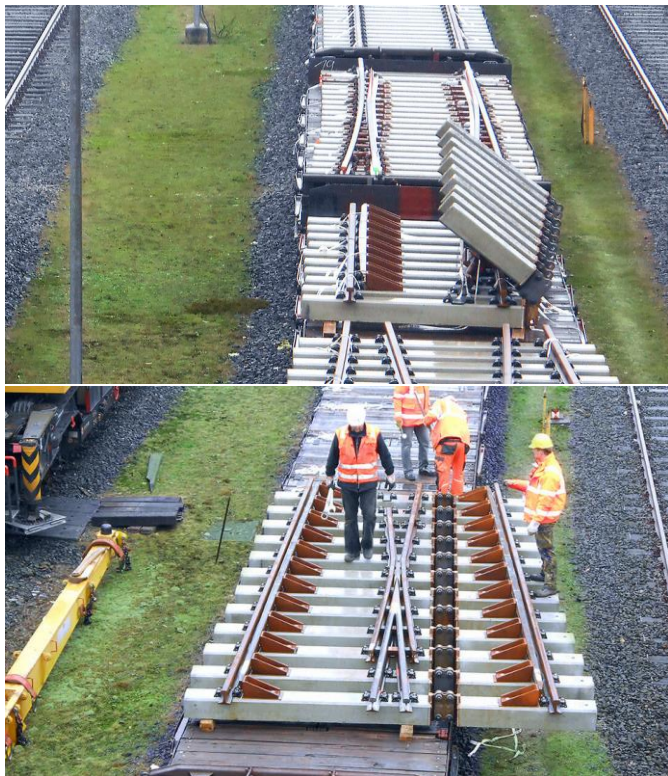

KOMPOZIT ALJAK

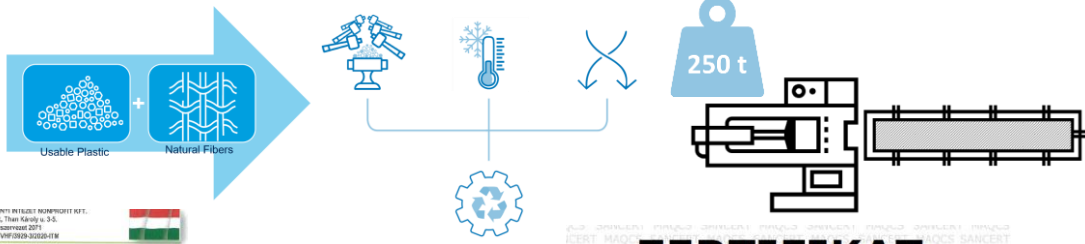

Tipusvizsgálati tanúsítvány

meet the following technical specifications:

Datasheets P90, P60 and P30 and EBA-approvals

ZERTIFIKÁT

Technische Universität München
Lehrstuhl und Prüfmatt für Verkehrswegebau

TUM

1. 3-Punkt-Biegung (Elastizitätsmodul)
2. Dynamischer Streckentest
3. 3-Punkt-Biegung (Berstmodul)

EBA* tanúsítvány (2021.05.)
- 225 kN & 160 km/h
- 250 kN & 120 km/h

EBA* tanúsítvány (2022.01.)
- 225 kN & 160 km/h
- 250 kN & 120 km/h

EBA* tanúsítvány (2022.04.)
- 225 kN & 120 km/h
- 250 kN & 100 km/h



P30	P60	P90
EBA* tanúsítvány (2021.05.) - 225 kN & 160 km/h - 250 kN & 120 km/h	EBA* tanúsítvány (2022.01.) - 225 kN & 160 km/h - 250 kN & 120 km/h	EBA* tanúsítvány (2022.04.) - 225 kN & 120 km/h - 250 kN & 100 km/h

BEÉPÍTÉS

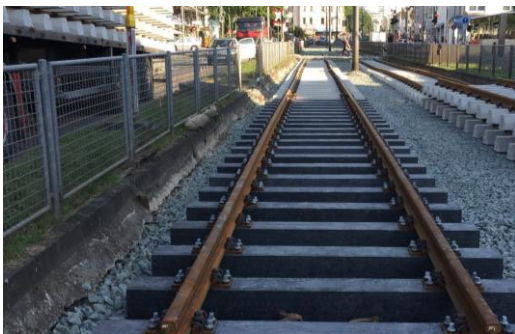

Nagyvasút & Városi Vasút

REFERENCIA

Budapest



Zöld & Innovatív

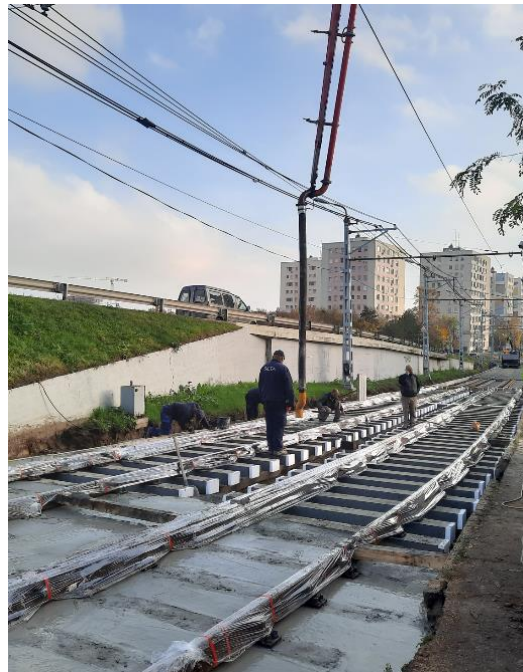

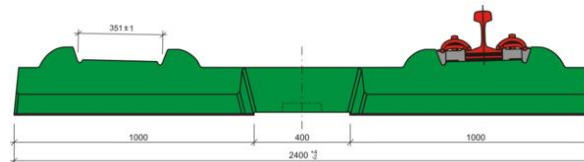
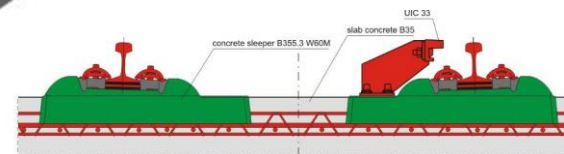
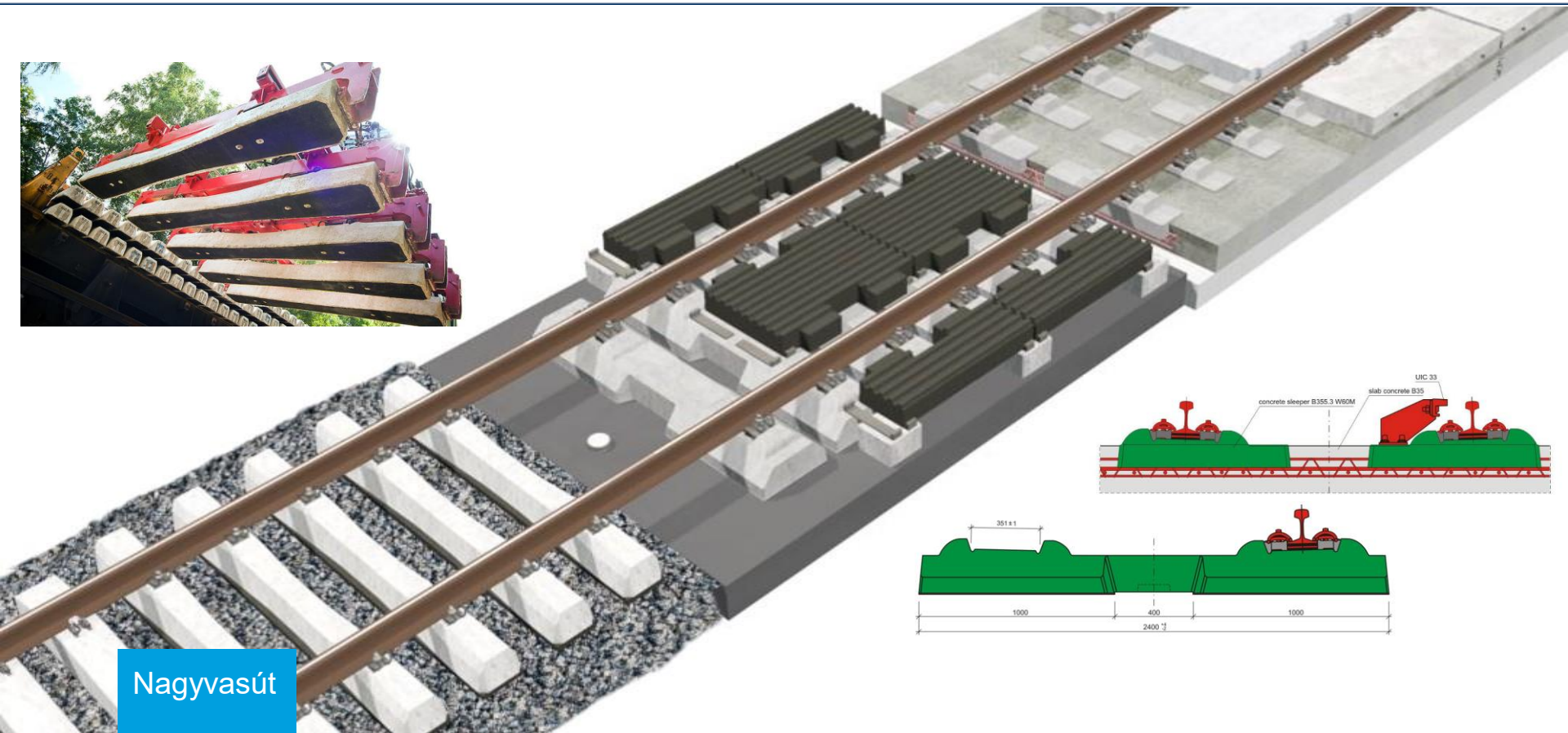

Nagyvasút

RHEDA 2000®



Több mint 4500 km lefektetett RHEDA 2000® típusú vágányszerkezet





Adaptív | Megbízhatóság kedvezőtlen építési viszonyok esetén



RHEDA 2000® = Moduláris

RHEDA 2000® beépítése és gyártása Magyarországon !



RHEDA 2000® = Költséghatékony

GETRACK RENDSZER

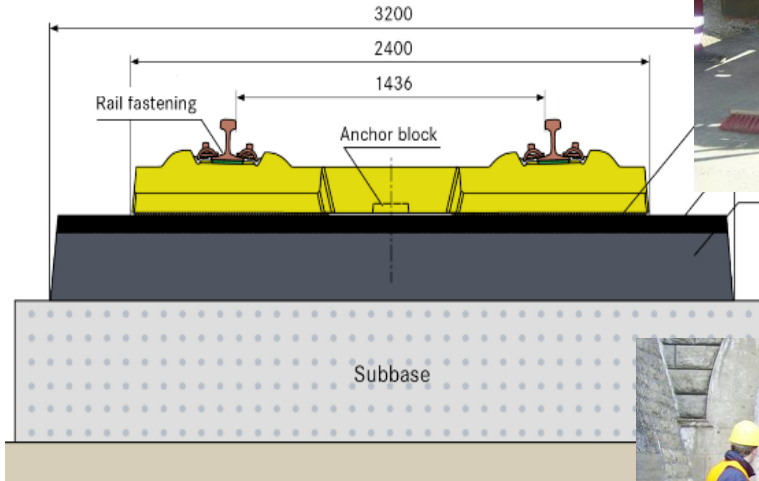

Getrack = Aszfalttechnológia

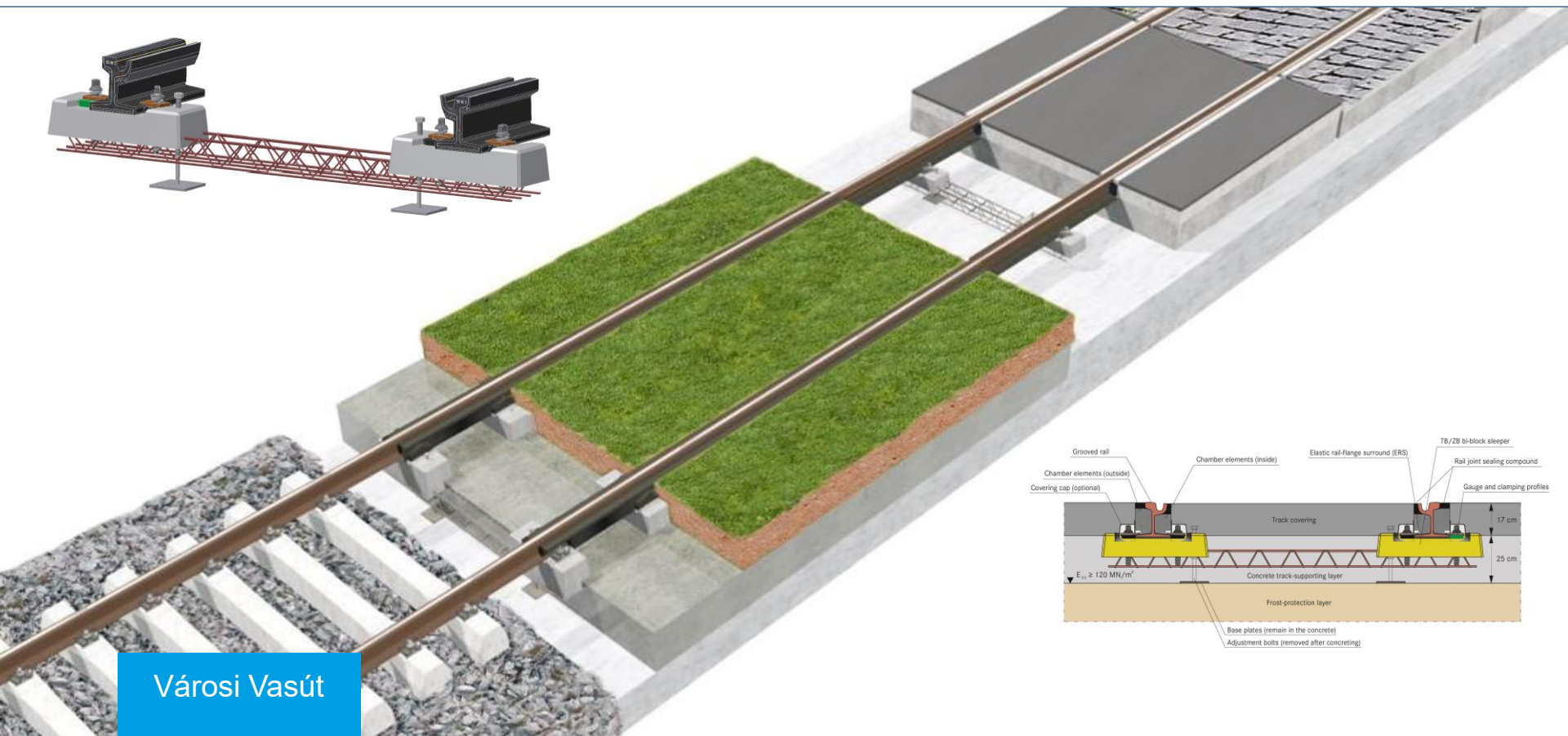

Városi Vasút

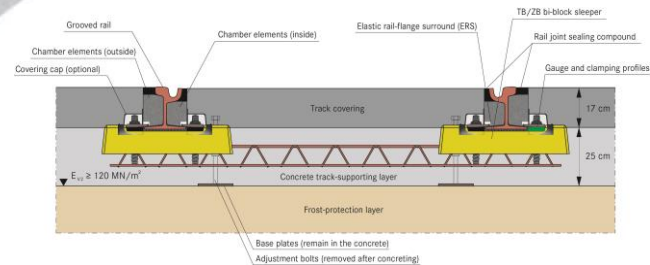

RHEDA CITY

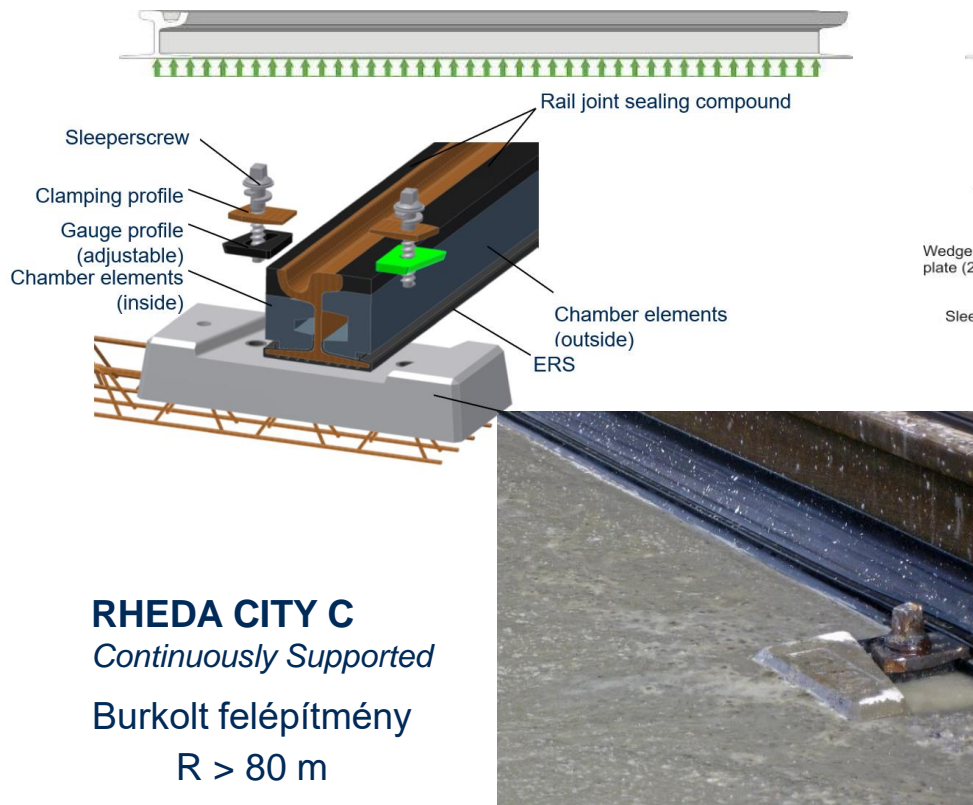

RHEDA CITY C
Continuously Supported
Burkolt felépítmény
R > 80 m

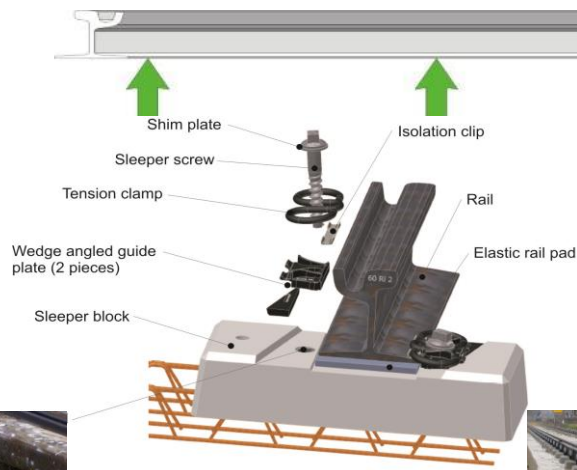

RHEDA CITY D
Discretely Supported
Nyitott felépítmény
25m > R < 80 m

NAGYPANELES VÁGÁNYELEMMEK



Gyors pályafelújítás



Köllő Szabolcs Attila
Engineer Application Engineering
Tel +36 30 391 3206
Tel +49 9181 8952-280
szabolcs.kollo@railone.com

PCM RAILONE AG
Dammstrasse 5
92318 Neumarkt | Germany

www.railone.com

The content and the design of this file are literary property of the PCM RAILONE AG or a connected company. They are protected by copyright. No reproduction or distribution is allowed without the prior written consent of the right owner.